

CATALOGUE PIECES DETACHEES JMSTAR CJ12M



SOMMAIRE

FILTRE A AIR	1	COMPTEUR	21
POT D'ECHAPPEMENT	2	FEU AVANT	22
CADRE	3	BAVETTE ARRIERE	23
FACE AVANT	6	COMMANDES GUIDON	24
CARROSSERIE	7	SYSTEME ELECTRIQUE	25
SUSPENSION ARRIERE	8	MAITRE CYLINDRE FREIN AV	26
FOURCHE AVANT	9	FREIN AVANT	27
RESERVOIR ESSENCE	10	BEQUILLES	28
SIEGE	11	MOTEUR	29
ROUE AVANT	12	CARTERS MOTEUR	30
ROUE ARRIERE	13	VILLEBREQUIN	31
GUIDON	14	DEMARREUR POMPE A HUIL	32
MARCHE PIED	15	ALLUMAGE	33
GARDE BOUE ARRIERE	16	CULASSE	34
PLASTIQUE GUIDON	17	COUVRE CULASSE	35
COFFRE AVANT	18	CARTER TRANSMISSION	36
PORTE BAGAGE	19	TRANSMISSION	37

FIG.1

No	Code	OBSERVATION	Description	Quantité	EUROS
01	AQUI01-001		CAPOT FILTRE A AIR	1	25,00
02	AQUI01-002		ELEMENT FILTRANT	1	34,00
03	AQUI01-003		SUPPORT FILTRE A AIR	1	25,00
05	AQUI01-005		TUBE FILTRE A AIR	1	30,00



FIG.2

No	Code	OBSERVATION	Description	Quantité	EUROS
01	AQUI02-001		CORPS POT ECHAPPEMENT	1	140,00
02	AQUI02-002		RECUPERATEUR GAZ BRULES	1	
11	AQUI02-011		RECUPERATEUR GAZ BRULES SEUL	2	45,00
04	AQUI02-004		SUPPORT POT COLLIERS	2	20,00
05	AQUI02-005		JOINT CAOUTCHOUC	2	10,00
10	AQUI02-010		SUPPORT SUSPENSION AR	1	75,00

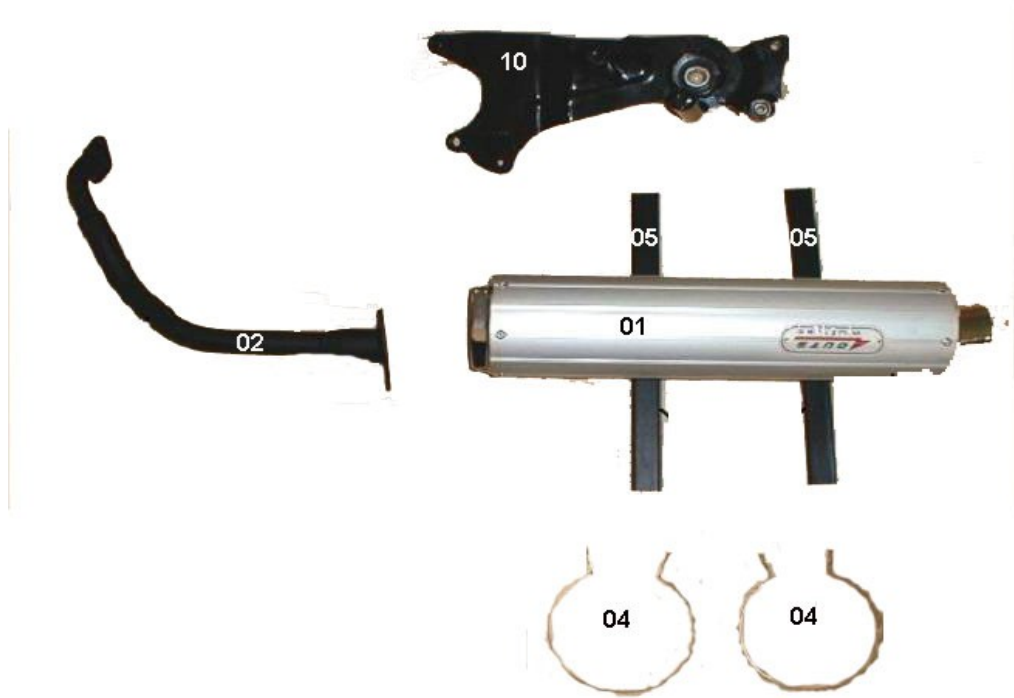

FIG.2

FIG.3

No	Code	OBSERVATION	Description	Quantité	EUROS
01	AQUI03-001		CADRE	1	450,00



FIG.3

FIG.4

No	Code	OBSERVATION	Description	Quantité	EUROS
01	AQUI04-01		SUPPORT AVANT	1	45,00



FIG.4

FIG.5

No	Code	OBSERVATION	Description	Quantité	EUROS
01	AQUI05-001		PIECE METAL	1	45,00
02	AQUI05-002		AXE MOTEUR	1	20,00



FIG.5

FIG 6

No	Code	OBSERVATION	Description	Quantité	EUROS
01	AQUI06-001		FACE AVANT SUP	1	60,00
02	AQUI06-002		FACE AVANT INF	1	120,00
03	AQUI06-003		PLASTIQUE LATERAL GAUCHE	1	20,00
04	AQUI06-004		PLASTIQUE LATERAL DROIT	1	20,00
05	AQUI06-005		GARDE BOUE AVANT FACE AVANT	1	45,00
06	AQUI06-006		GARDE BOUE AVANT FACE ARRIERE	1	30,00



FIG.6

FIG.7

No	Code	OBSERVATION	Description	Quantité	EUROS
01	AQUI07-001		PLASTIQUE LATERALE GAUCHE SUPERIEURE	1	60,00
02	AQUI07-002		PLASTIQUE LATERALE DROITE SUPERIEURE	1	60,00
03	AQUI07-003		PLASTIQUE CENTRAL SOUS SELLE	1	25,00
04	AQUI07-004		PLASTIQUE CENTRAL TRAPPE GRILLE	1	15,00
05	AQUI07-005		FACE LATERALE GAUCHE	1	25,00
06	AQUI07-006		FACE LATERALE DROITE	1	25,00
07	AQUI07-007		PLASTIQUE ARRIERE 1	1	20,00
08	AQUI07-008		PLASTIQUE ARRIERE 2	1	15,00
09	AQUI07-009		PLASTIQUE LATERALE GAUCHE INFERIEUR	1	25,00
10	AQUI07-010		PLASTIQUE LATERALE DROITE INFERIEUR	1	25,00

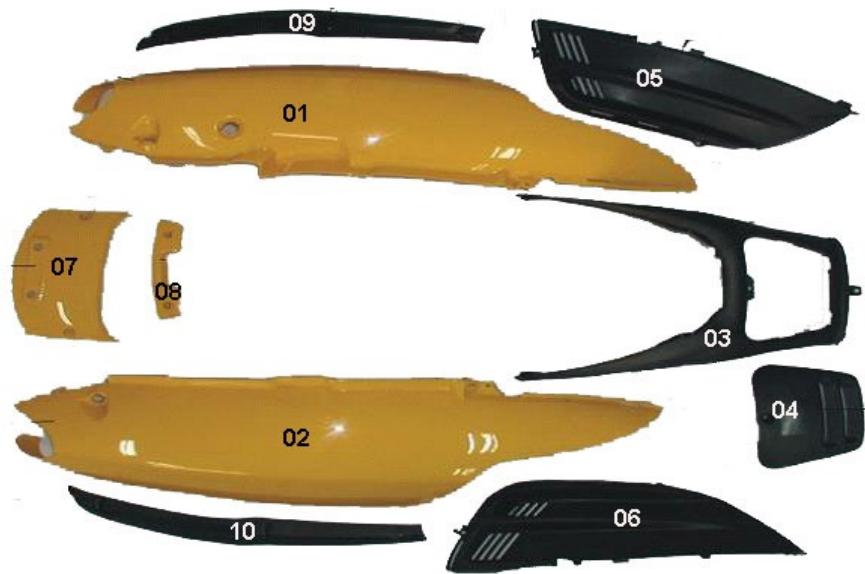

FIG.7

FIG.8

No	Code	OBSERVATION	Description	Quantité	EUROS
01	AQUI08-001		SUPPORT SUSPENSION ARRIERE	1	75,00
02	AQUI08-002		AMORTISSEURS ARRIERE	2	90,00



FIG.8

FIG.9

No	Code	OBSERVATION	Description	Quantité	EUROS
01	AQUI09-001		T DE FOURCHE	1	90,00
02	AQUI09-002		SUSPENSION AVANT GAUCHE	1	50,00
03	AQUI09-003		SUSPENSION AVANT DROITE	1	50,00
04	AQUI09-004		KIT DE DIRECTION	1	35,00



FIG.9

FIG.10

No	Code	OBSERVATION	Description	Quantité	EUROS
01	AQUI10-001		RESERVOIR ESSENCE	1	60,00
02	AQUI10-002		BOUCHON RESERVOIR	1	15,00
03	AQUI10-003		JAUGE	1	25,00
04	AQUI10-004		SUPPORT RESERVOIR	1	25,00
05	AQUI10-005		ROBINET A DEPRESSION	1	17,00
06	AQUI10-006		DURIT	1	5,00
07	AQUI10-007		FILTRE A ESSENCE	1	8,00

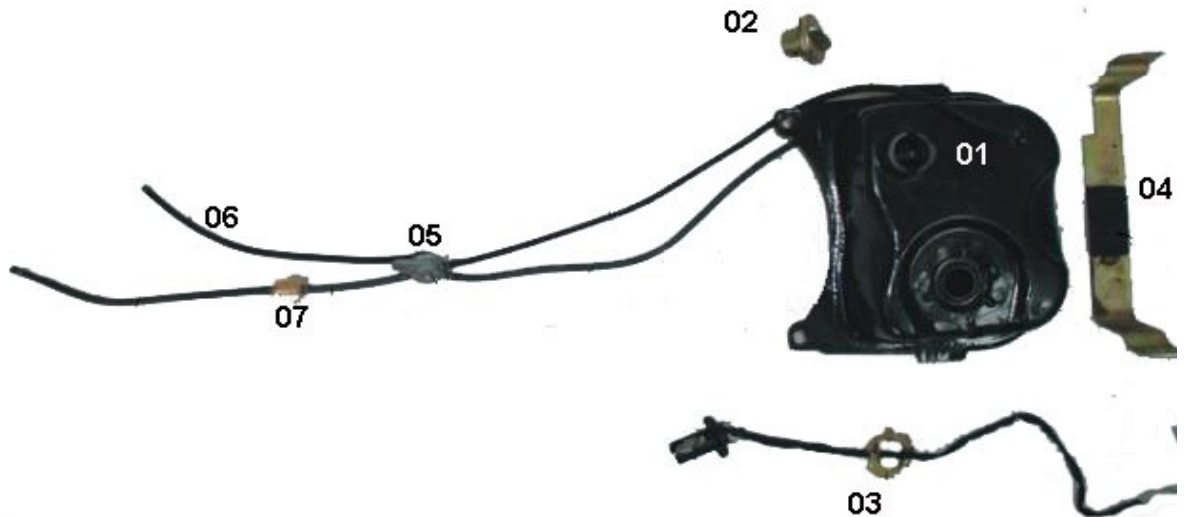

FIG.10

FIG.11

No	Code	OBSERVATION	Description	Quantité	EUROS
01	AQUI11-001		SELLE	1	80,00
02	AQUI11-002		PLASTIQUE SOUS SELLE	1	45,00
03	AQUI11-003		PLASTIQUE ACCES CARBU	1	15,00
04	AQUI11-004		SYSTEME SERRURE COFFRE	1	30,00



FIG.11

FIG.12

No	Code	OBSERVATION	Description	Quantité	EUROS
01	AQUI12-001		JANTE ROUE AVANT	1	90,00
02	AQUI12-002		AXE ROUE AVANT	1	20,00
03	AQUI12-003		RECEVEUR COMPTEUR	1	25,00
04	AQUI12-004		DISQUE FREIN AVANT	1	49,00
05	AQUI12-005		PNEU AVANT	1	40,00
06	AQUI12-006		VALVE	1	10,00



FIG.12

FIG.13

No	Code	OBSERVATION	Description	Quantité	EUROS
01	AQUI13-001		JANTE ROUE ARRIERE	1	90,00
02	AQUI13-002		PNEU ARRIERE	1	40,00
03	AQUI13-003		TAMBOUR DE FREIN	1	40,00
04	AQUI13-004		VALVE ROUE ARRIERE	1	10,00

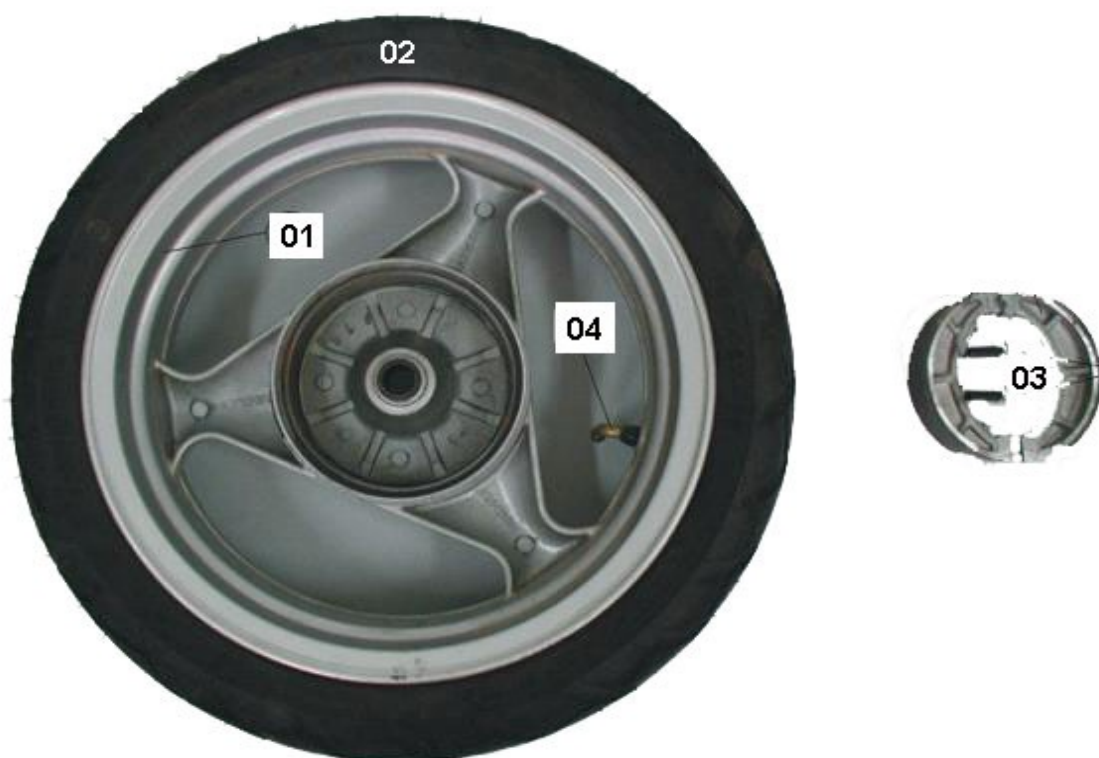

FIG.13

FIG.14

No	Code	OBSERVATION	Description	Quantité	EUROS
01	AQUI14-001		GUIDON	1	45,00
02	AQUI14-002		PIECE CABLE ACCELARATEUR	1	20,00
03	AQUI14-003		POIGNEE ACCELERATEUR	1	20,00
04	AQUI14-004		CABLE ACCELERATEUR	1	25,00
05	AQUI14-005		CABLE DE FREIN ARRIERE	1	25,00
06	AQUI14-006		LEVIER FREIN ARRIERE	1	29,00
07	AQUI14-007		PIECE FREIN ARRIERE	1	35,00
08	AQUI14-008		CABLE FEU STOP	1	15,00
09	AQUI14-009		POIGNEE GAUCHE	1	15,00

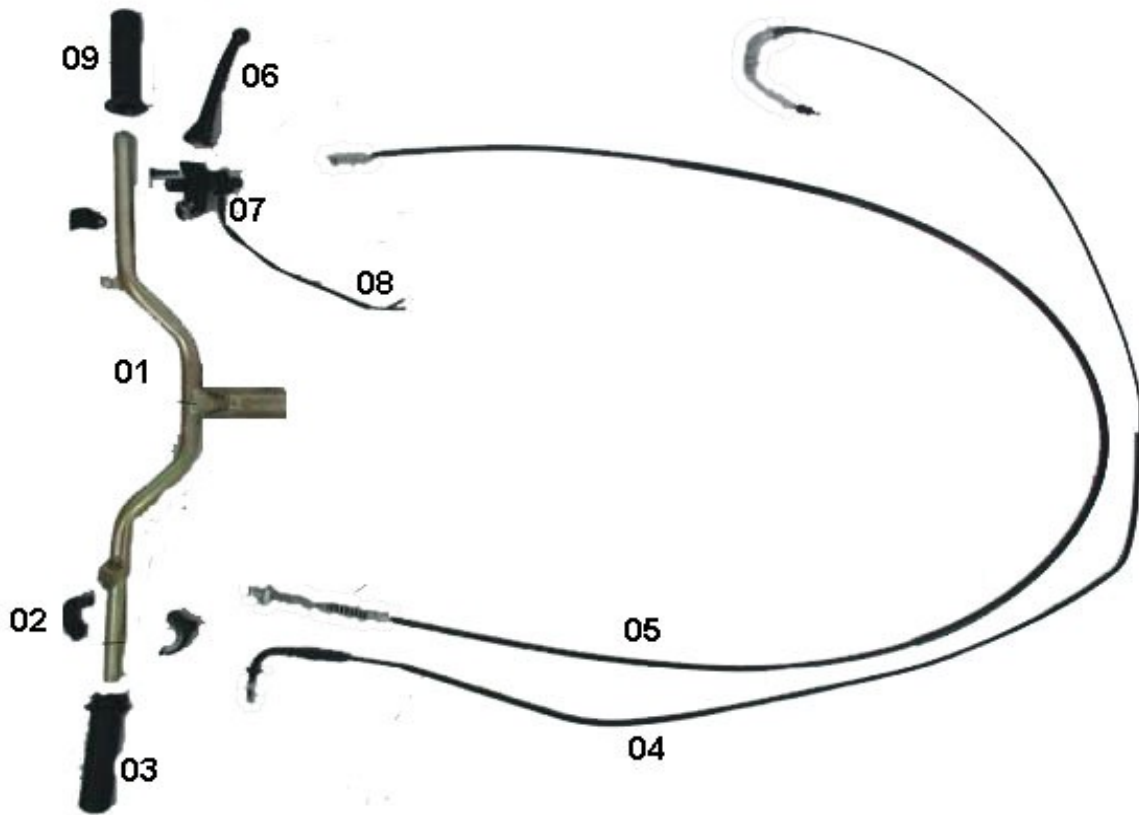

FIG.14

FIG.15

No	Code	OBSERVATION	Description	Quantité	EUROS
01	AQUI15-001		PLASTIQUE SOL	1	45,00
02	AQUI15-002		COUVRE BATTERIE	1	15,00
03	AQUI15-003		REPOSES PIEDS PASSAGER	2	40,00
04	AQUI15-004		TAPIS DE SOL	1	35,00



FIG.15

FIG.16

No	Code	OBSERVATION	Description	Quantité	EUROS
01	AQUI16-001		GARDE BOUE ARRIERE	1	35,00



FIG.16

FIG.17

No	Code	OBSERVATION	Description	Quantité	EUROS
01	AQUI17-001		PLASTIQUE GUIDON	1	49,00
02	AQUI17-002		CACHE FREIN DROIT	1	15,00
03	AQUI17-003		CACHE FREIN GAUCHE	1	15,00
04	AQUI17-004		PLASTIQUE COMPTEUR	1	39,00
05	AQUI17-005		RETROVISEUR DROIT	1	29,00
06	AQUI17-006		RETROVISEUR GAUCHE	1	29,00

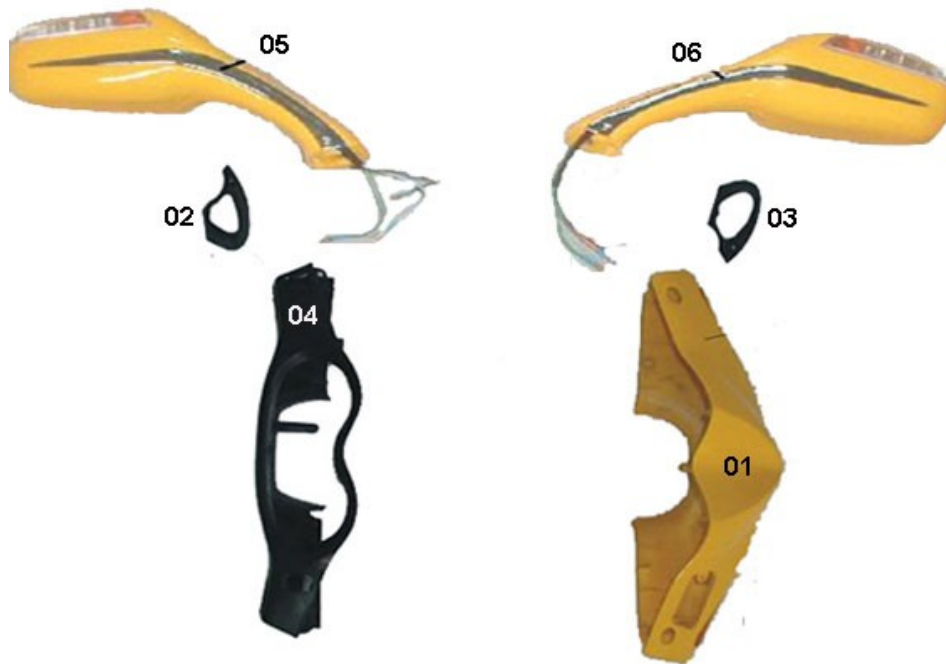

FIG.18

No	Code	OBSERVATION	Description	Quantité	EUROS
01	AQUI18-001		COFFRE AVANT	1	75,00
02	AQUI18-002		PORTE COFFRE AVANT	1	29,00
03	AQUI18-003		PORTE PAQUET	1	15,00
04	AQUI18-004		CACHE N° DE SERIE	1	10,00

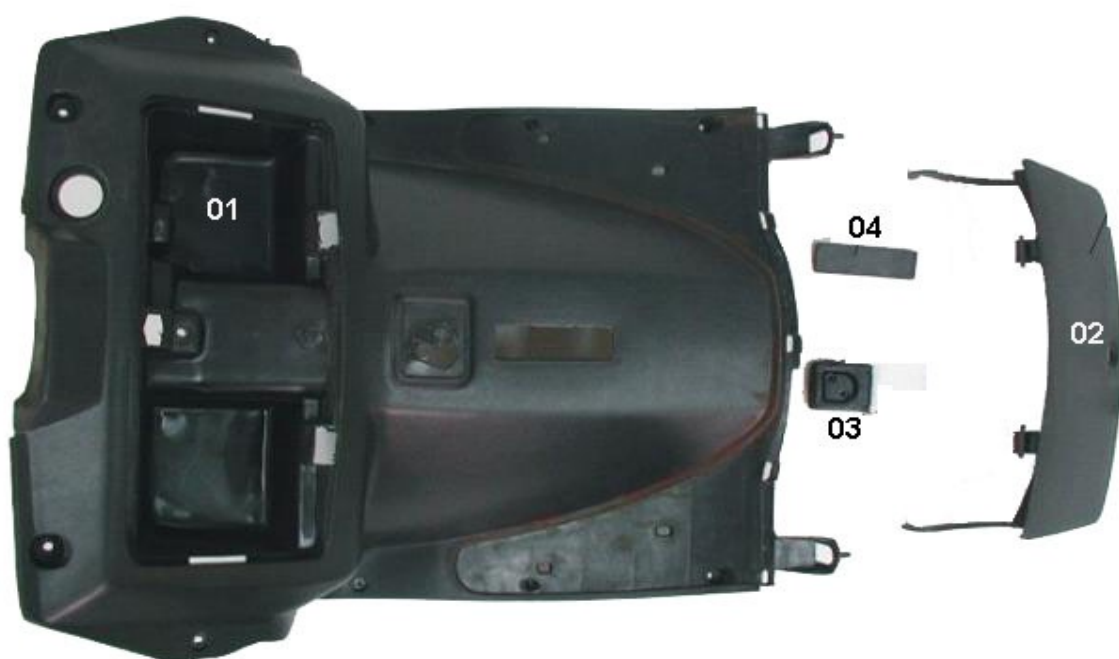

FIG.18

FIG.19

No	Code	OBSERVATION	Description	Quantité	EUROS
01	AQU19-001		CLIGNOTANT AVANT GAUCHE	1	35,00
02	AQU19-002		CLIGNOTANT AVANT DROIT	1	35,00



FIG.20

No	Code	OBSERVATION	Description	Quantité	EUROS
01	AQUI20-001		CACHE PORTE BAGAGE	1	45,00
02	AQUI20-002		PORTE BAGAGES	1	25,00

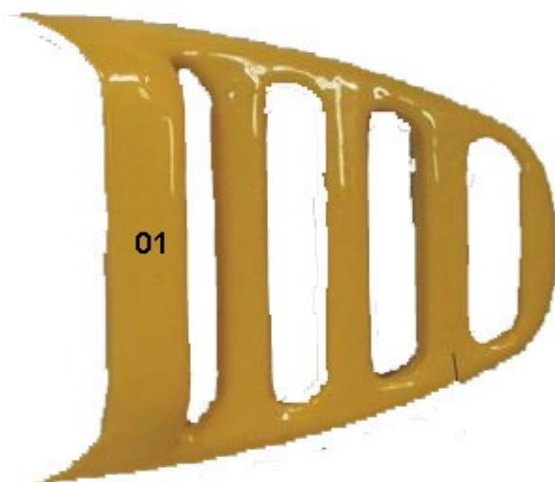

FIG.20

FIG.21

No	Code	OBSERVATION	Description	Quantité	EUROS
01	AQUI21-001		COMPTEUR	1	80,00
02	AQUI21-002		CABLE ELECTRIQUE COMPTEUR	1	35,00
03	AQUI21-003		CABLE COMPTEUR	1	25,00

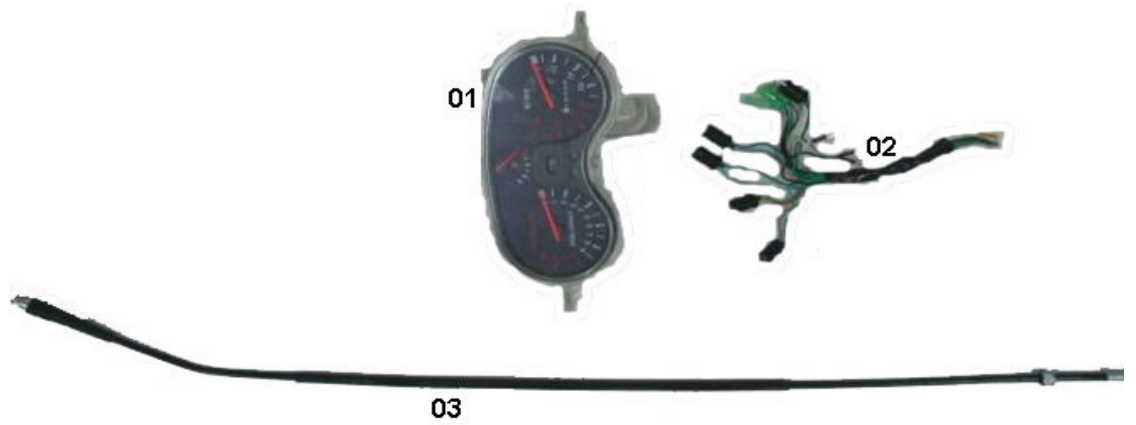

FIG.21

FIG.22

No	Code	OBSERVATION	Description	Quantité	EUROS
01	AQUI22-001		FEUX AVANTS	1	90,00
02	AQUI22-002		CABLE ELECTRIQUE FEUX AVANTS	1	49,00

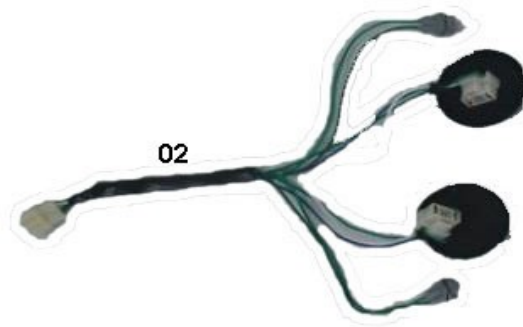

FIG.23

No	Code	OBSERVATION	Description	Quantité	EUROS
01	AQUI23-001		BAVETTE ARRIERE	1	55,00
02	AQUI23-002		CACHE FEU ARRIERE	1	12,00
03	AQUI23-003		CACHE CLIGNOTANT ARRIERE GAUCHE	1	10,00
04	AQUI23-004		CACHE CLIGNOTANT ARRIERE DROIT	1	10,00
05	AQUI23-005		CACHE AMPOULE PLAQUE	1	12,00
06	AQUI23-006		FAISCEAU FEU ARRIERE	1	40,00



FIG.23

FIG.24

No	Code	OBSERVATION	Description	Quantité	EUROS
01	AQUI24-001		BOUTON KLAXON	1	10,00
02	AQUI24-002		BOUTON CLIGNOTANTS	1	10,00
03	AQUI24-003		COMMUTATEUR CODE/PHARE	1	10,00
04	AQUI24-004		BOUTON FEUX	1	10,00
05	AQUI24-005		PLASTIQUE COMPTEUR	1	45,00
06	AQUI24-006		BOUTON DEMARREUR ELECTRIQUE	1	10,00
07	AQUI24-007		BOUTON WARNING	1	10,00



FIG.25

No	Code	OBSERVATION	Description	Quantité	EUROS
01	AQUI25-001		BOITIER CDI	1	49,00
02	AQUI25-002		BATTERIE	1	55,00
03	AQUI25-003		BOBINE ALLUMAGE	1	35,00
04	AQUI25-004		RELAIS DEMARREUR	1	35,00
05	AQUI25-005	Vendu avec serrure coffre et boîte à gant	NEIMAN	1	60,00
06	AQUI25-006		KLAXON	1	20,00
07	AQUI25-007		REGULATEUR DE TENSION	1	35,00
08	AQUI25-008		RELAIS CLIGNOTANTS	1	35,00
09	AQUI25-009		FAISCEAU PRINCIPAL	1	90,00
10	AQUI25-010		FAISCEAU SECONDAIRE	1	70,00

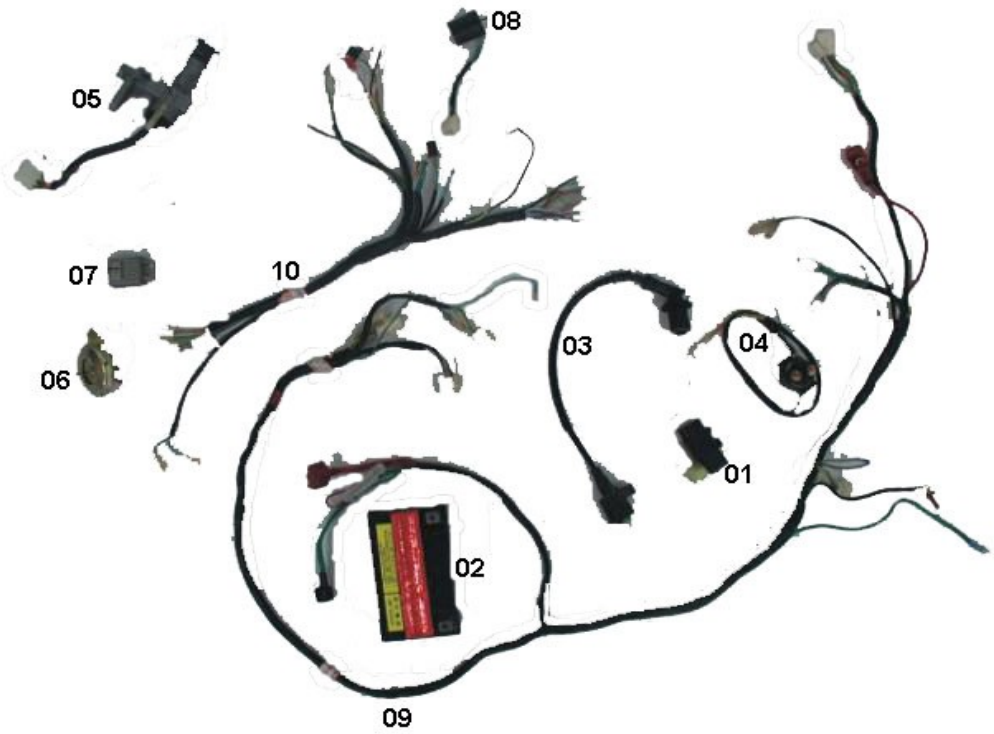

FIG.25

FIG.26

No	Code	OBSERVATION	Description	Quantité	EUROS
01	AQUI26-001		MAITRE CYLINDRE	1	49,00
02	AQUI26-002		DURITE FREIN AVANT	1	49,00
03	AQUI26-003		LEVIER FREIN AVANT	1	29,00



FIG.26

FIG.27

No	Code	OBSERVATION	Description	Quantité	EUROS
01	AQUI27-001		PIECE METALLIQUE FREIN AVANT	1	20,00
02	AQUI27-002		ETRIER FREIN AVANT COMPLET	1	50,00
03	AQUI27-003		JEU PLAQUETTES	1	30,00



FIG.27

FIG.28

No	Code	OBSERVATION	Description	Quantité	EUROS
01	AQUI28-001		CACHE DESSOUS	1	30,00
02	AQUI28-002		BEQUILLE CENTRALE	1	49,00
03	AQUI28-003		BEQUILLE LATERALE	1	39,00

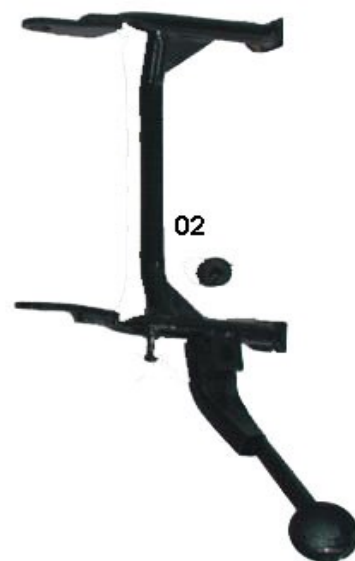

FIG.28

FIG.29

No	Code	OBSERVATION	Description	Quantité	EUROS
01	AA-22-000		MOTEUR COMPLET	1	450

FIG 30

No	Code	OBSERVATION	Description	Quantité	EUROS
01	AQUI30-001		CARTER MOTEUR DROIT	1	90,00
02	AQUI30-002		JOINT CARTER	1	10,00
03	AQUI30-003		CARTER MOTEUR GAUCHE	1	150,00

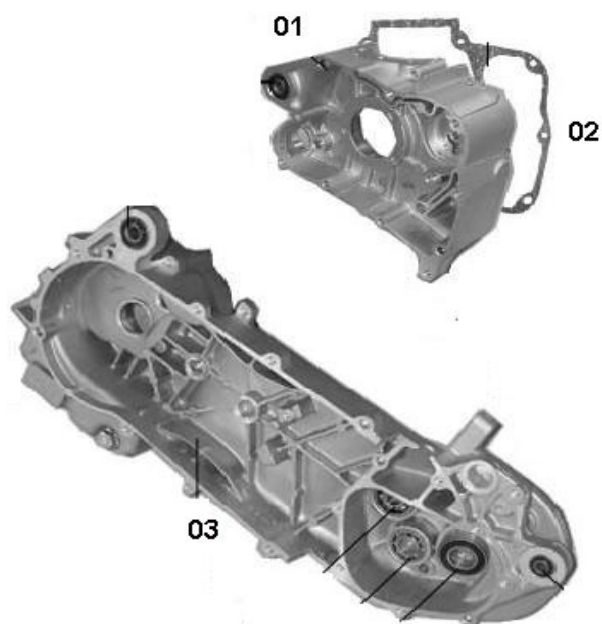

FIG 31

No	Code	OBSERVATION	Description	Quantité	EUROS
01	AQUI31-001		VILLEBREQUIN	1	90,00
02	AQUI31-002		AXE DE PISTON	1	20,00
03	AQUI31-003		PISTON	1	50,00
04	AQUI31-004		SEGMENTS	-	30,00
05	AQUI31-005		JOINT D'EMBASE	1	10,00
06	AQUI31-006		GUIDE CHAINE GAUCHE	1	25,00
07	AQUI31-007		GUIDE CHAINE DROIT	1	25,00
08	AQUI31-008		CHAINE	1	40,00
09	AQUI31-009		CYLINDRE	1	95,00
10	AQUI31-010		TENDEUR DE CHAINE	1	50,00

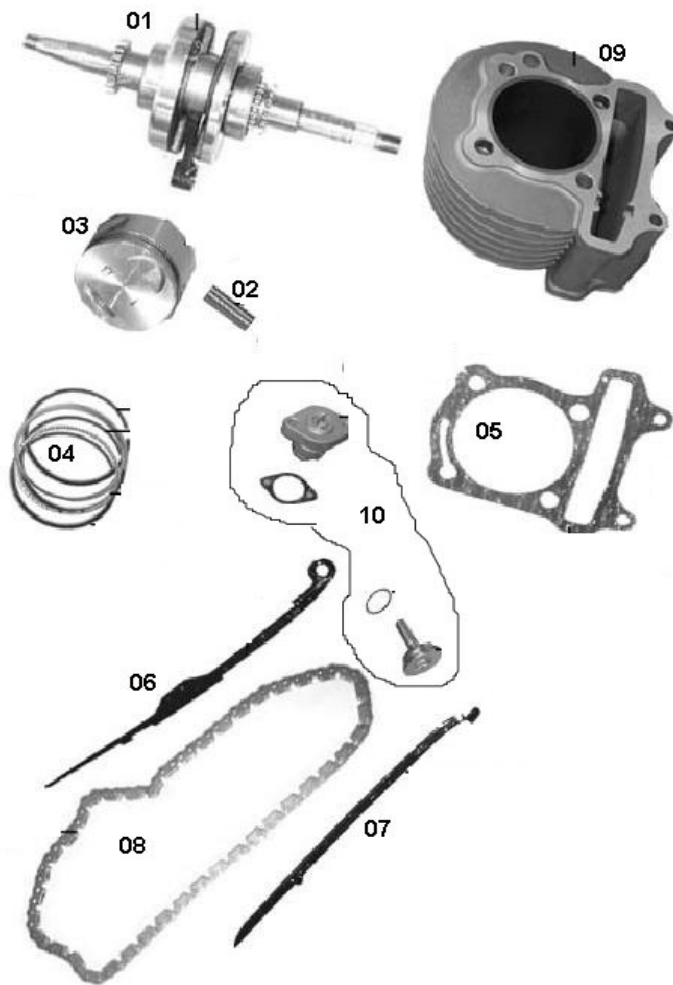

FIG 32

No	Code	OBSERVATION	Description	Quantité	EUROS
01	AQUI32-001		DEMARREUR ELECTRIQUE	1	60,00
02	AQUI32-002		ROUE LIBRE	1	70,00
03	AQUI32-003		ENSEMBLE POMPE A HUILE	1	80,00
04	AQUI32-004		CHAINE POMPE A HUILE	1	49,00

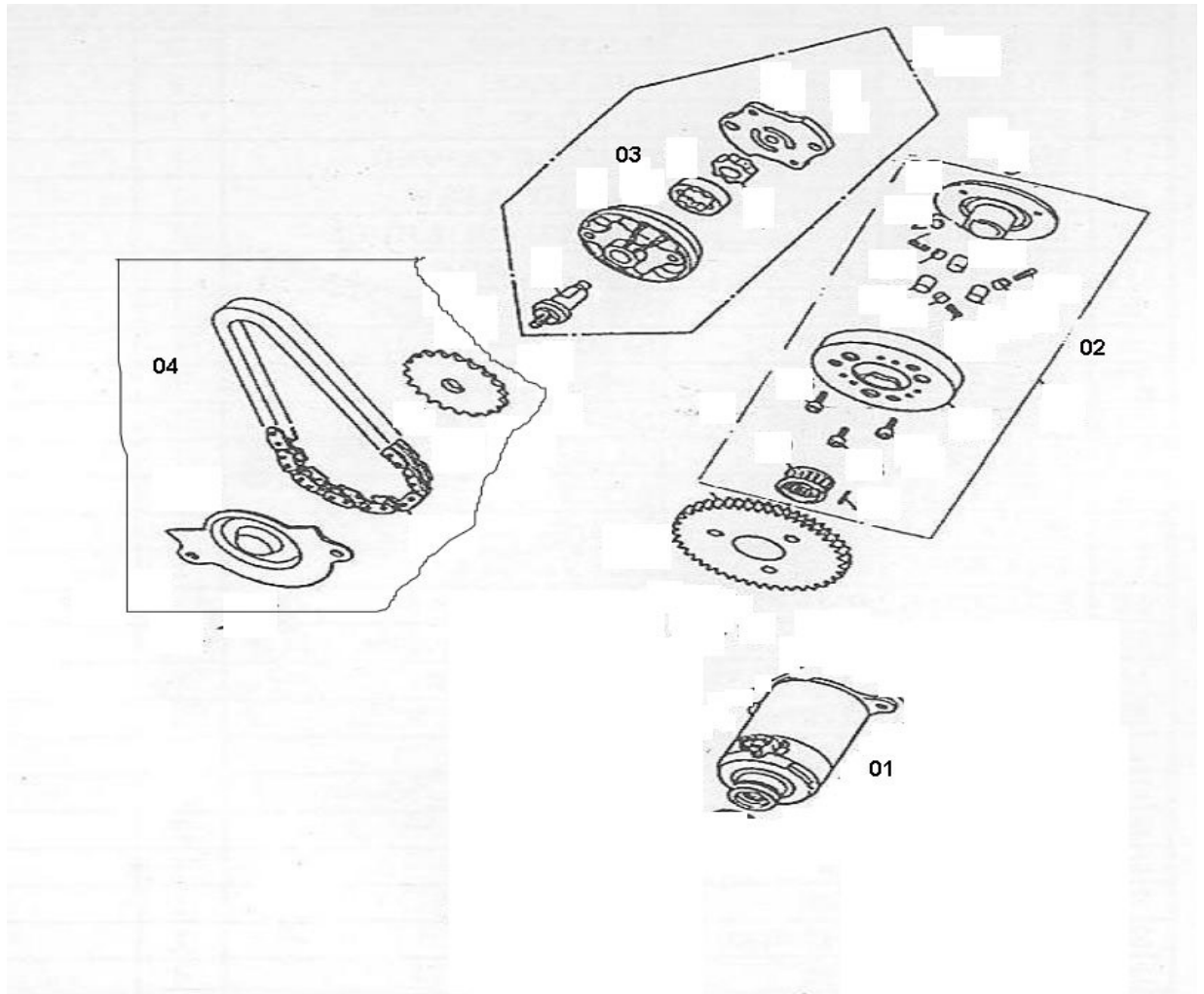

FIG 33

No	Code	OBSERVATION	Description	Quantité	EUROS
01	AQUI33-001		CARTER MOTEUR	1	50,00
02	AQUI33-002		BOUCHON JAUGE HUILE	1	20,00
03	AQUI33-003		FILTRE A HUILE	1	15,00
04	AQUI33-004		BOUCHON VIDANGE HUILE	1	20,00
05	AQUI33-005		ROTOR	1	40,00
06	AQUI33-006		STATOR	1	89,00
07	AQUI33-007		VENTILATEUR	1	30,00

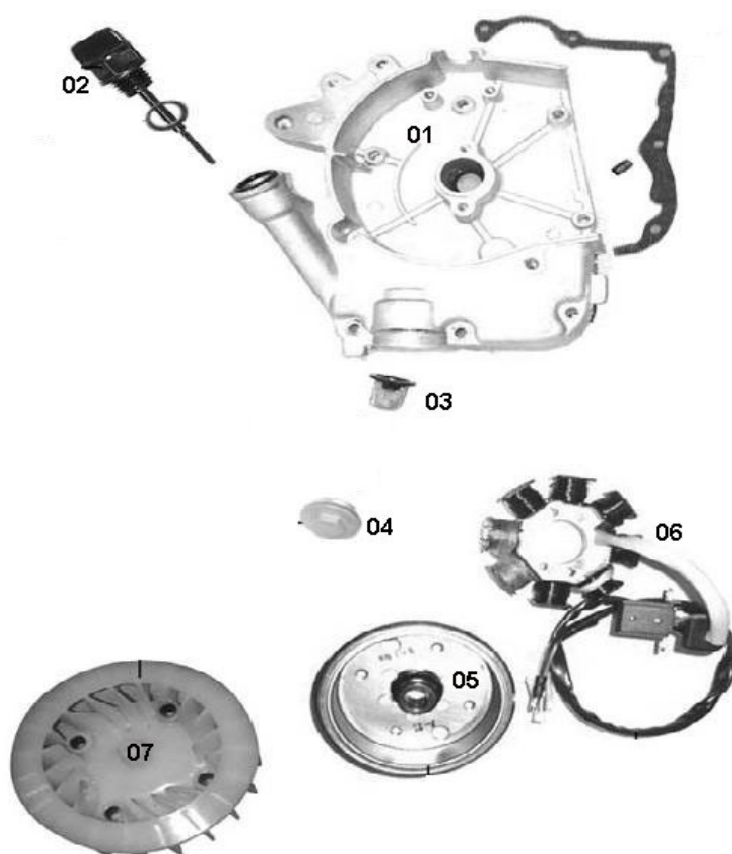

FIG.28

FIG 34

No	Code	OBSERVATION	Description	Quantité	EUROS
01	AQUI34-001		CULASSE	1	80,00
02	AQUI34-002		JOINT DE CULASSE	1	20,00
03	AQUI34-003		PIPE D'ADMISSION	1	39,00
04	AQUI34-004		CARBURATEUR	1	85,00
05	AQUI34-005		CULBUTEUR	1	70,00
06	AQUI34-006		ARBRE A CAME	1	70,00
07	AQUI34-007		SOUPAPE D'ADMISSION	1	15,00
08	AQUI34-008		SOUPAPE D'ECHAPPEMENT	1	15,00
09	AQUI34-009		BOUGIE	1	8,00

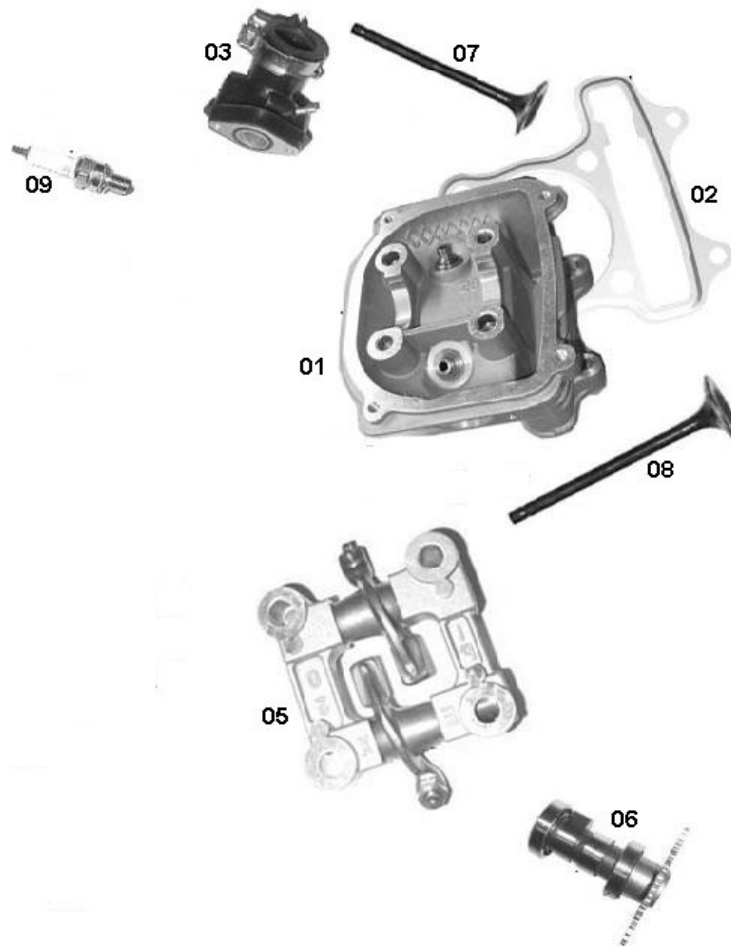

FIG 35

No	Code	OBSERVATION	Description	Quantité	EUROS
01	AQUI35-001		TETE DE CULASSE	1	69,00
02	AQUI35-002		COUVRE VENTILATEUR	1	40,00
03	AQUI35-003		PLASTIQUE PROTECTION MOTEUR	1	39,00
04	AQUI35-004		JOINT	1	10,00



FIG 36

No	Code	OBSERVATION	Description	Quantité	EUROS
01	AQUI36-001		CARTER MOTEUR	1	79,00
02	AQUI36-002		JOINT DE CARTER	1	20,00
03	AQUI36-003		DEMI LUNE	1	39,00
04	AQUI36-004		NOIX DE KICK	1	30,00
05	AQUI36-005		KICK	1	30,00

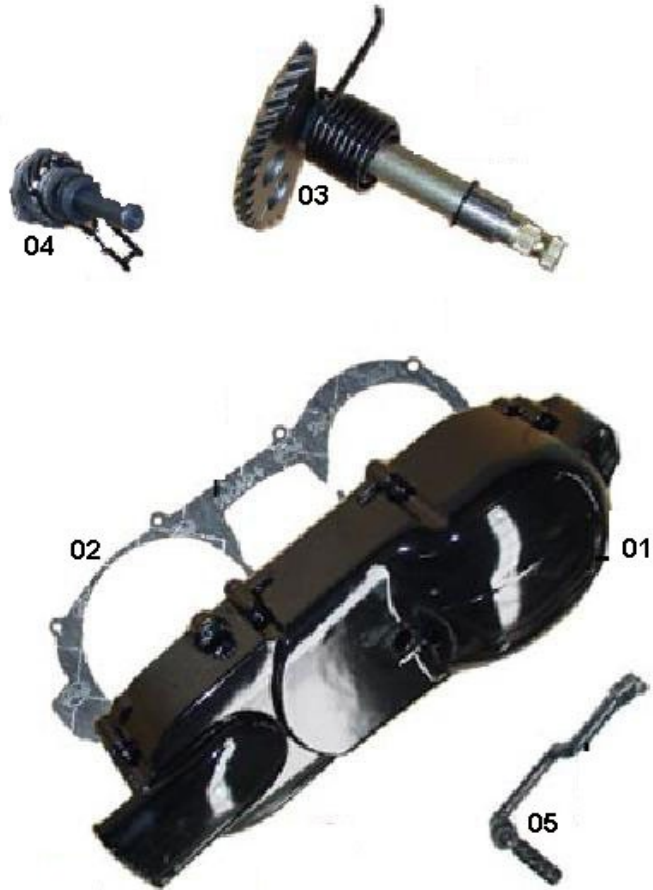

FIG 37

No	Code	OBSERVATION	Description	Quantité	EUROS
01	AQUI37-001		EMBAYAGE	1	70,00
02	AQUI37-002		COURROIE	1	35,00
03	AQUI37-003		ENGRENAGE KICK	1	20,00
04	AQUI37-004		AXE VARIATEUR	1	30,00
05	AQUI37-005		VARIATEUR COMPLET	1	80,00



FIG.28

FIG 38

No	Code	OBSERVATION	Description	Quantité	EUROS
01	AQUI38-001		CARTER DE TRANSMISSION	1	70,00
02	AQUI38-002		JOINT DE CARTER TRANSMISSION	1	20,00
03	AQUI38-003		JOINT SPY	1	15,00
04	AQUI38-004		AXE TRANSMISSION 1	1	30,00
05	AQUI38-005		ENGRENAGE 1	1	25,00
06	AQUI38-006		AXE TRANSMISSION 2	1	30,00
07	AQUI38-007		ENGRENAGE 2	1	25,00

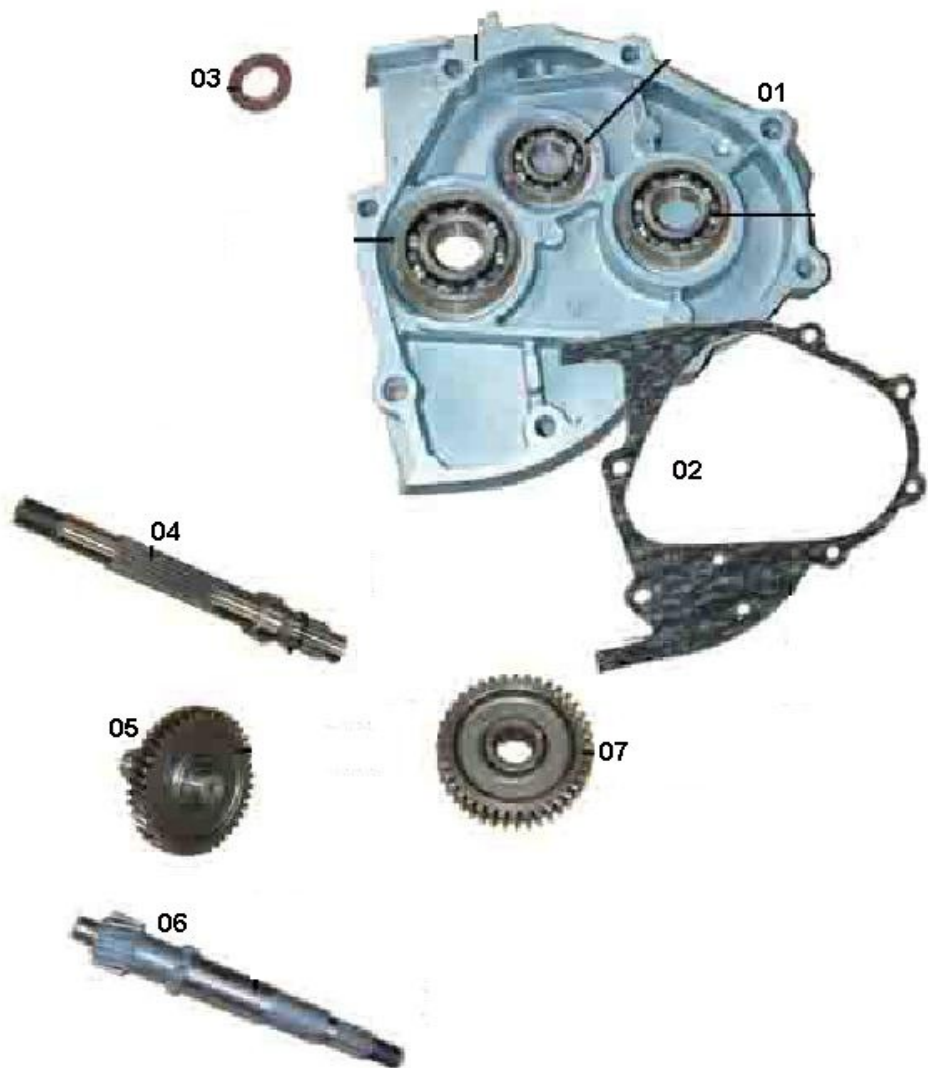

FIG.28